

Top Entry Ball Valve Series



Top Entry Ball Valve Series

Pressure Class :Class 150~2500

Size Range : 2"~40"

API Standards:6D

ASME B 16.34

Usage

The top entry ball valve is mainly used on Pipelines and industrial system. It has such advantages as top online maintenance function, small fluid resistance, simple structure, reliable sealing, convenient operation and closing, etc. The driving modes include manual operation. Worm and worm gear transmission, Pneumatic operation and electric operation. The connection ends can be flange or butt welding.

Structural Features

1. Integral structure

The body adopts the integral structure, so as to ensure that it has enough strength and rigidity under the maximum rated working pressure. The valve trims have been carefully designed and selected to ensure reliability under various service conditions. The sufficient wall thickness and the connection bolts of high strength are very helpful to the maintenance and servicing of valves and are able to endure pipeline stress.

2. Top Entry Structure

The valve adopts the top entry structure. The most distinctive difference between this kind of valve and others is that the online maintenance function can be realized without the need of removing the valve from the pipeline. The seat adopts the concession type seat structure, and the rear end of the seat retainer is set as oblique angle to prevent impurities accumulated on the seat from influencing the concession of seat.

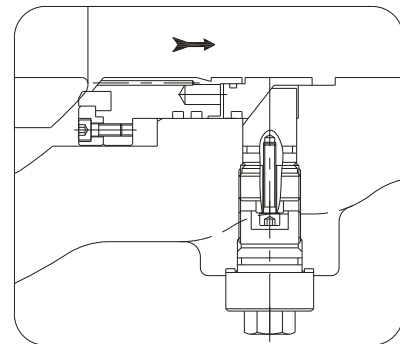
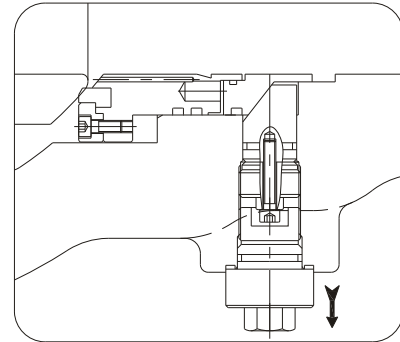

1	Body
2	Ball
3	Seat
4	Seat ring
5	O-ring
6	Spring
7	Anti-fire packing
8	Anti-static device
9	O-ring
10	Sliding bearing
11	Thrust bearing
12	O-ring
13	Anti-fire gasket
14	Bonnet
15	Stud
16	Hexagon nut
17	Packing
18	Packing gland
19	Socket head cap screw
20	Fly key
21	Thrust bearing
22	Anti-fire gasket
23	Lower cover
24	Check valve
25	Sealing injection valve
26	Sealing gasket
27	Socket head cap screw
28	Air release valve
29	Drainage valve

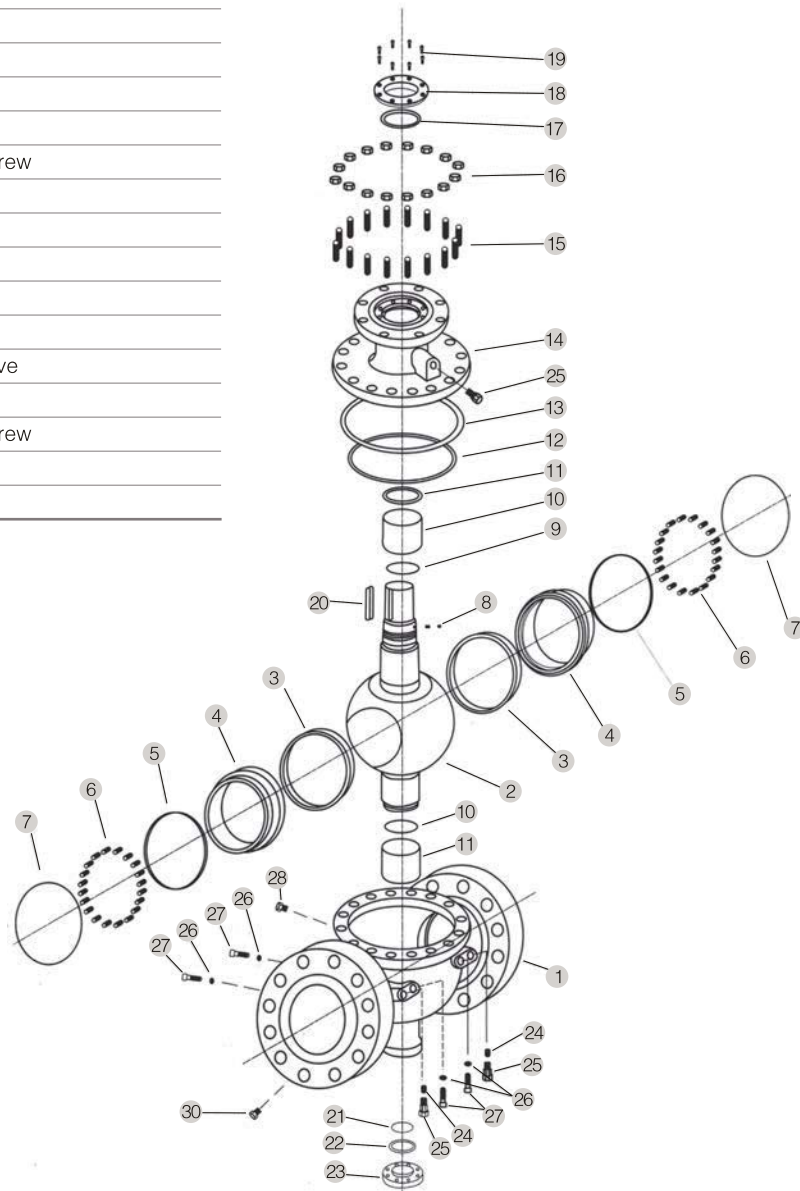

Part Materials and Main Parameters

Nominal diameter (in)		NPS 2~36					
Nominal Pressure (MPa)		Class150~Class900					
Materials of parts	No.	Part Name	Material				
			Carbon steel	Stainless steel			
	1	Body	ASTM A216 WCB	ASTM A351 CF8	ASTM A351 CF8M	ASTM A351 CF3	ASTM A351 CF3M
	2	Ball	ASTM A105 · ENP	ASTM A182 304	ASTM A182 316	ASTM A182 304L	ASTM A182 316L
	3	Seat	PTFE/NYLON/PEEK/PPL				
	4	Seat ring	ASTM A105 · ENP	ASTM A182 304	ASTM A182 316	ASTM A182 304L	ASTM A182 316L
	5	O-ring	VITON				
	6	Spring	17-7PH				
	7	Anti-fire packing	Graphite				
	8	Anti-static device	Combined parts	Combined parts	Combined parts	Combined parts	Combined parts
	9	O-ring	VITON				
	10	Sliding bearing	Metal+PTFE	Metal+PTFE	Metal+PTFE	Metal+PTFE	Metal+PTFE
	11	Thrust bearing	PTFE				
	12	O-ring	VITON				
	13	Anti-fire gasket	SST+Graphite				
	14	Bonnet	ASTM A216 WCB	ASTM A351 CF8	ASTM A351 CF8M	ASTM A351 CF8	ASTM A351 CF3M
	15	Stud	A193 B7M	A320 B8	A320 B8M	A320 B8	A320 B8M
	16	Hexagon nut	A194-2HM	A194-8	A194-8M	A194-8	A194-8M
	17	Packing					
	18	Packing gland	ASTM A105 · ENP	ASTM A182 304	ASTM A182 316	ASTM A182 304L	ASTM A182 316L
	19	Socket head cap screw	A193 B7M	A320 B8	A320 B8M	A320 B8	A320 B8M
	20	Fly key	ANSI 1045	ANSI 1045	ANSI 1045	ANSI 1045	ANSI 1045
	21	Thrust bearing	PTFE				
	22	Anti-fire gasket	SST+Graphite				
	23	Lower cover	ASTM A105 · ENP	ASTM A182 304	ASTM A182 316	ASTM A182 304L	ASTM A182 316L
	24	Check valve	Combined parts	Combined parts	Combined parts	Combined parts	Combined parts
	25	Sealing injection valve	Combined parts	Combined parts	Combined parts	Combined parts	Combined parts
	26	Sealing gasket	SST+Graphite				
	27	Socket head cap screw	A193 B7M	A320 B8	A320 B8M	A320 B8	A320 B8M
28	Air release valve	Combined parts	Combined parts	Combined parts	Combined parts	Combined parts	
29	Drainage valve	Combined parts	Combined parts	Combined parts	Combined parts	Combined parts	
Applicable service conditions	Applicable media	Water, steam, oil, gas, liquefied gas, natural gas, etc.	Nitric acid	Acetic acid	Strong Oxidizer	Urea	
	Applicable temperature	120°C(PTFE)、≤80°C(NYLON)、≤250°C(PEEK)、≤250°C(PPL)					
Design and manufacturing		API 608、API 6D					
Face-to-face dimensions		ASME B16.10、API 6D、JIS B2002					
Type of connection		Flange	ASME B16.5/ASME B16.47		Butt welding	ASME B16.25	
Pressure test		API 598、API6D					
Transmission mode		Manual, worm and worm gear transmission, pneumatic, electric					

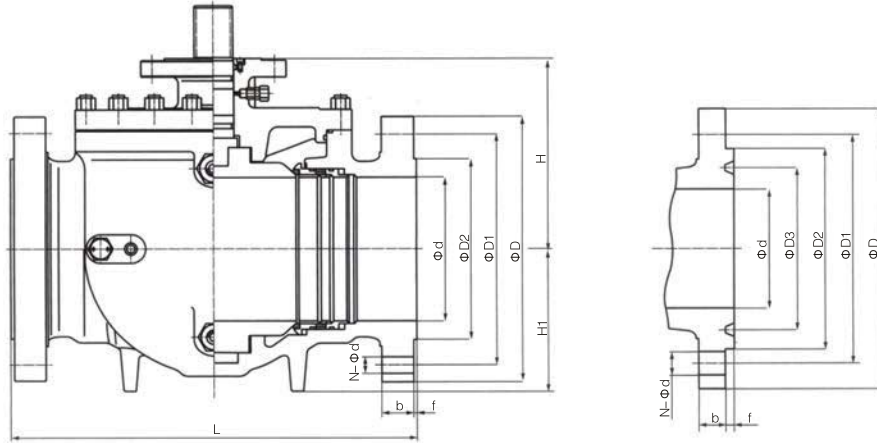

Pressure rating	Nominal Diameter		d	Flange		Butt welding	Flanged						H	H1	Weight (kg)		
	Class	NPS		DN	L(RF)		L(RTJ)	L(BW)	D	D1	D2	D3				f	b
150		2"	50	50	292	295	292	150	120.5	92	/	2	14.5	4-Φ19	130	102	Δ
		3"	80	75	283	298	283	190	152.5	127	/	2	17.5	4-Φ19	163	150	Δ
		4"	100	100	432	435	432	230	190.5	157	/	2	22.5	8-Φ19	177	175	Δ
		6"	150	150	559	562	559	280	241.5	216	/	2	24	8-Φ22	240	231	Δ
		8"	200	201	660	664	660	345	298.5	270	/	2	27	8-Φ22	266	256	Δ
		10"	250	252	787	791	787	405	362	324	/	2	29	12-Φ25	324	303.5	Δ
		12"	300	303	838	841	838	485	432	381	/	2	30.5	12-Φ25	383	310	Δ
		14"	350	334	889	892	889	535	476	413	/	2	33.5	12-Φ29	390	300	Δ
		16"	400	385	991	994	991	595	540	470	/	2	35	16-Φ29	435	340	Δ
		18"	450	436	1092	1095	1092	635	578	533	/	2	38.5	16-Φ32	522	410	Δ
		20"	500	487	1194	1200	1194	700	635	584	/	2	41.5	20-Φ32	565	445	Δ
		24"	600	589	1394	1407	1394	815	749.5	692	/	2	46.5	20-Φ35	618	480	Δ
		26"	650	633	1448	/	1448	870	806.5	749	/	2	68	24-Φ35	660	540	Δ
		28"	700	684	1549	/	1549	927	864	800	/	2	71	28-Φ35	690	596	Δ
		30"	750	735	1651	/	1651	984	914.5	857	/	2	75	28-Φ35	770	620	Δ
	32"	800	779	1778	/	1778	1060	978	914	/	2	81	28-Φ41	838	680	Δ	
	36"	900	874	2083	/	2083	1168	1086	1022	/	2	90	32-Φ41	910	710	Δ	
300		2"	50	50	292	295	292	165	127	92	/	2	21	8-Φ19	130	102	Δ
		3"	80	75	283	298	283	210	168.5	127	/	2	27	8-Φ22	163	150	Δ
		4"	100	100	432	435	432	255	200	157	/	2	30.5	8-Φ22	177	175	Δ
		6"	150	150	559	562	559	320	270	216	/	2	35	12-Φ22	240	231	Δ
		8"	200	201	660	664	660	380	330	270	/	2	40	12-Φ25	266	276	Δ
		10"	250	252	787	791	787	445	387.5	324	/	2	46.5	16-Φ29	324	303.5	Δ
		12"	300	303	939	841	939	520	451	381	/	2	49.5	16-Φ32	383	362	Δ
		14"	350	334	889	892	889	585	514.5	413	/	2	52.5	20-Φ32	390	300	Δ
		16"	400	385	991	994	991	650	571.5	470	/	2	56	20-Φ35	440	365	Δ
		18"	450	436	1092	1095	1092	710	628.5	533	/	2	59	24-Φ35	535	420	Δ
		20"	500	487	1194	1200	1194	775	686	584	/	2	62	24-Φ35	575	450	Δ
		24"	600	589	1394	1407	1394	915	813	692	/	2	68.5	24-Φ42	640	490	Δ
		26"	650	633	1448	/	1448	972	876.5	749	/	2	79	28-Φ45	680	560	Δ
		28"	700	684	1549	/	1549	1035	940	800	/	2	86	28-Φ45	720	610	Δ
		30"	750	735	1651	/	1651	1092	997	957	/	2	92	28-Φ48	808	640	Δ
	32"	800	779	1778	/	1778	1149	1054	914	/	2	98	28-Φ51	860	700	Δ	
	36"	900	874	2083	/	2083	1270	1168	1022	/	2	105	32-Φ54	935	730	Δ	

Δ Please consult the factory:

Note: The weight value is only for flanged valve. Please consult our factory for higher nominal diameter or weight. Any modification to size Hand, weight will not be notified otherwise.

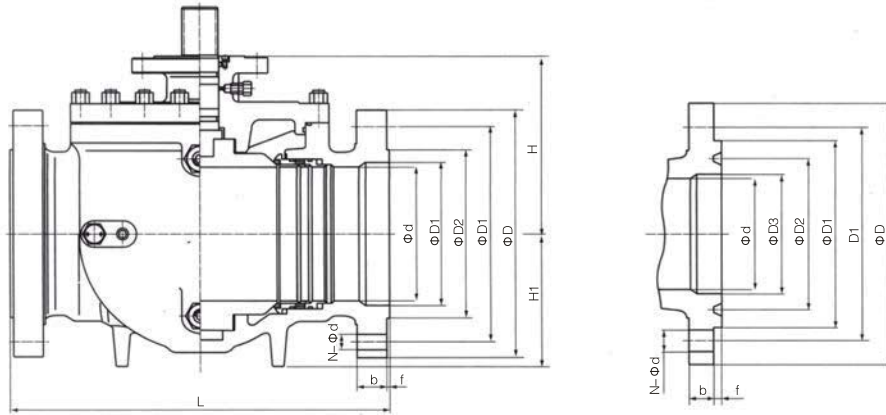

Pressure rating	Nominal Diameter		d	d1	Flange		Butt welding	Flanged						H	H1	Weight (kg)	
	Class	NPS			DN	L(RF)		L(RTJ)	L(BW)	D	D1	D2	D3				f
150	3"x2"	80	50	75	283	298	283	190	152.5	127	/	2	17.5	4-φ19	130	102	Δ
	4"x3"	100	75	10	432	435	432	230	190.5	157	/	2	22.5	8-φ19	163	150	Δ
	6"x4"	150	100	150	559	562	559	280	241.5	216	/	2	24	8-φ22	177	175	Δ
	8"x6"	200	150	201	660	664	660	345	298.5	270	/	2	27	8-φ22	240	231	Δ
	10"x8"	250	201	252	787	791	787	405	362	324	/	2	29	12-φ25	266	256	Δ
	12"x10"	300	252	303	838	841	838	485	432	381	/	2	30.5	12-φ25	324	303.5	Δ
	14"x10"	350	252	334	889	892	889	535	476	413	/	2	33.5	12-φ29	324	303.5	Δ
	14"x12"	350	303	334	889	892	889	535	476	413	/	2	33.5	12-φ29	383	310	Δ
	16"x12"	400	303	385	991	994	991	595	540	470	/	2	35	16-φ29	383	310	Δ
	16"x14"	400	334	385	991	994	991	595	540	470	/	2	35	16-φ29	390	300	Δ
	18"x16"	450	385	436	1092	1095	1092	635	578	533	/	2	38.5	16-φ32	435	340	Δ
	20"x16"	500	385	487	1194	1200	1194	700	635	584	/	2	41.5	20-φ32	435	340	Δ
	20"x18"	500	436	487	1194	1200	1194	700	635	584	/	2	41.5	20-φ32	522	410	Δ
	24"x20"	600	487	589	1397	1407	1397	815	749.5	692	/	2	46.5	20-φ35	565	445	Δ
30"x24"	750	589	735	1651	/	1651	984	914.5	847	/	2	75	28-φ35	618	480	Δ	
36"x30"	900	735	874	2083	/	2083	1168	1086	1022	/	2	90	32-φ41	770	620	Δ	
300	3"x2"	80	50	75	283	298	283	210	168.5	127	/	2	27	8-φ22	130	102	Δ
	4"x3"	100	75	100	432	435	432	255	200	157	/	2	30.5	8-φ22	163	150	Δ
	6"x4"	150	100	150	559	562	559	320	270	216	/	2	35	12-φ22	177	175	Δ
	8"x6"	200	150	201	660	664	660	380	330	270	/	2	40	12-φ25	240	231	Δ
	10"x8"	250	201	252	787	791	787	445	387.5	324	/	2	46.5	16-φ29	266	276	Δ
	12"x10"	300	252	303	838	841	838	520	451	381	/	2	49.5	16-φ32	324	303.5	Δ
	14"x10"	350	252	334	889	892	889	585	514.5	413	/	2	52.5	20-φ32	324	303.5	Δ
	14"x12"	350	303	334	889	892	889	585	514.5	413	/	2	52.5	20-φ32	383	362	Δ
	16"x12"	400	303	385	991	994	991	650	571.5	470	/	2	56	20-φ32	383	362	Δ
	16"x14"	400	334	385	991	994	991	650	571.5	470	/	2	56	20-φ35	390	300	Δ
	18"x16"	450	385	436	1092	1095	1092	710	628.5	533	/	2	59	24-φ35	440	365	Δ
	20"x16"	500	385	487	1194	1200	1194	775	686	584	/	2	62	24-φ35	440	365	Δ
	20"x18"	500	436	487	1194	1200	1194	775	686	584	/	2	62	24-φ35	535	420	Δ
	24"x20"	600	487	589	1397	1407	1397	915	813	692	/	2	68.5	24-φ41	575	450	Δ
30"x24"	750	589	735	1651	/	1651	1092	997	847	/	2	92	28-φ48	640	490	Δ	
36"x30"	900	735	874	2083	/	2083	1270	1168	1022	/	2	105	32-φ54	808	640	Δ	

Δ Please consult the factory:
 Note: The weight value is only for flanged valve. Please consult our factory for higher nominal diameter or weight. Any modification to size Hand, weight will not be notified otherwise.

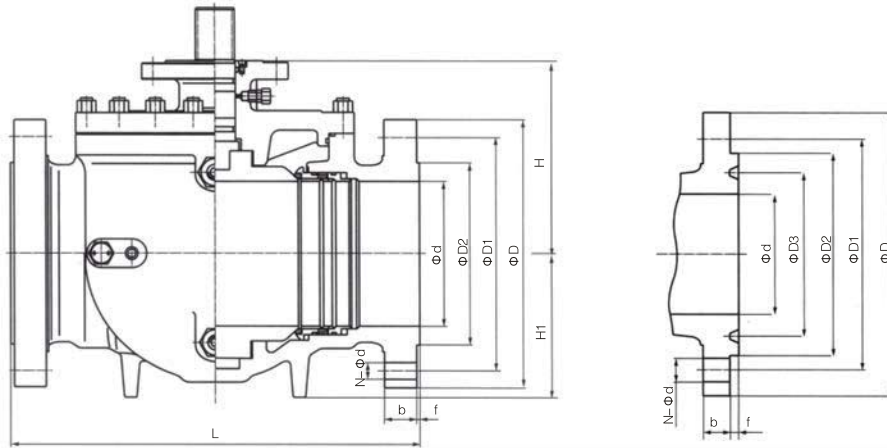

Pressure rating	Nominal Diameter		d	Flange		Butt welding	Flanged						H	H1	Weight (kg)			
	Class	NPS		DN	L(RF)		L(RTJ)	L(BW)	D	D1	D2	D3				f	b	N-Ød
600		2"	50	50	292	295	292	165	127	92	/	7	26	8-Ø19	142	110	Δ	
		3"	80	75	356	359	356	210	168.5	127	/	7	32	8-Ø22	188	165	Δ	
		4"	100	100	432	435	432	275	216	17	/	7	38.5	8-Ø25	205	193	Δ	
		6"	150	150	559	562	559	355	292	216	/	7	48	12-Ø29	255	242	Δ	
		8"	200	201	660	664	660	420	349	270	/	7	56	12-Ø32	282	269	Δ	
		10"	250	252	787	791	787	510	432	324	/	7	64	16-Ø35	369	339	Δ	
		12"	300	303	838	841	838	560	489	381	/	7	67	20-Ø35	402	300	Δ	
		14"	350	334	889	892	889	605	527	413	/	7	70	20-Ø39	410	320	Δ	
		16"	400	385	991	994	991	685	603	470	/	7	77	20-Ø41	467	360	Δ	
		18"	450	436	1092	1095	1092	745	654	533	/	7	83	20-Ø44	560	430	Δ	
		20"	500	487	1194	1200	1194	815	724	584	/	7	89	24-Ø44	633	490	Δ	
	24"	600	589	1397	1407	1397	940	838	692	/	7	102	24-Ø51	692	536	Δ		
900		2"	50	50	368	371	368	215	165	124	95.25	7.92	38.5	8-Ø25	160	112	Δ	
		3"	80	75	381	384	381	240	190.5	156	123.83	7.92	38.5	8-Ø25	213	168	Δ	
		4"	100	100	457	460	457	290	235	181	149.23	7.92	45	8-Ø32	232	197.5	Δ	
		6"	150	150	610	613	610	380	317.5	241	211.12	7.92	56	12-Ø32	289	258	Δ	
		8"	200	201	737	740	737	470	393.5	308	269.88	7.92	64	12-Ø39	319	294	Δ	
		10"	250	252	838	841	838	545	470	362	323.85	7.92	70	16-Ø39	407	372	Δ	
		12"	300	303	965	968	965	610	533.5	419	381	311.12	7.92	79.5	20-Ø39	443	329	Δ
		14"	350	322	1029	1038	1029	640	559	467	419.1	11.13	86	20-Ø42	467	345	Δ	
		16"	400	373	1130	1140	1130	705	616	524	469.9	11.13	89	20-Ø45	527	388	Δ	
		18"	450	423	1219	1232	1219	785	686	594	533.4	12.7	102	20-Ø51	632	463	Δ	
		20"	500	471	1321	1334	1321	855	749.5	648	584.2	12.7	108	20-Ø54	715	537	Δ	
	24"	600	570	1549	1568	1549	1040	901.5	772	692.15	15.88	140	20-Ø67	782	573	Δ		

Δ Please consult the factory:

Note: The weight value is only for flanged valve. Please consult our factory for higher nominal diameter or weight. Any modification to size Hand, weight will not be notified otherwise.

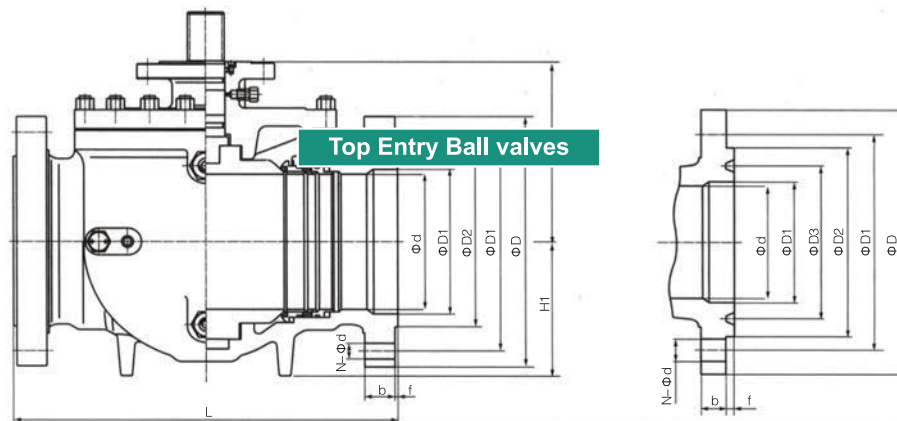

Pressure rating	Nominal Diameter		d	d1	Flange		Butt welding	Flanged						H	H1	Weight (kg)		
	Class	NPS			DN	L(RF)		L(RTJ)	L(BW)	D	D1	D2	D3				f	b
600		3"x2"	80	50	75	356	359	356	210	168.5	127	/	7	32	8-ø22	142	110	Δ
		4"x3"	100	75	100	432	435	432	275	216	157	/	7	38.5	8-ø25	188	165	Δ
		6"x4"	150	100	150	559	562	559	355	292	216	/	7	48	12-ø29	205	193	Δ
		8"x6"	200	150	201	660	664	660	420	349	270	/	7	56	12-ø32	255	242	Δ
		10"x8"	250	201	252	787	791	787	510	432	324	/	7	64	16-ø35	285	268	Δ
		12"x10"	300	252	303	838	841	838	560	489	381	/	7	67	20-ø35	369	339	Δ
		14"x10"	350	252	334	889	892	889	605	527	413	/	7	70	20-ø39	369	339	Δ
		14"x12"	350	303	334	889	892	889	605	527	413	/	7	70	20-ø39	402	300	Δ
		16"x12"	400	303	385	991	994	991	685	603	470	/	7	77	20-ø41	402	300	Δ
		16"x14"	400	334	385	991	994	991	685	603	470	/	7	77	20-ø41	410	320	Δ
		18"x16"	450	385	436	1092	1095	1092	745	645	533	/	7	83	20-ø44	467	360	Δ
		20"x16"	500	385	487	1194	1200	1194	815	724	584	/	7	89	24-ø44	467	360	Δ
		20"x18"	500	436	487	1194	1200	1194	815	724	584	/	7	89	24-ø44	560	430	Δ
	24"x20"	600	487	589	1397	1407	1397	940	838	692	/	7	102	24-ø51	633	490	Δ	
900		3"x2"	80	50	75	381	384	381	240	190.5	156	123.83	7.92	38.5	8-ø25	160	112	Δ
		4"x3"	100	75	100	457	460	457	290	235	181	149.23	7.92	45	8-ø25	213	168	Δ
		6"x4"	150	100	150	610	613	610	380	317.5	241	211.12	7.92	56	12-ø32	232	197.5	Δ
		8"x6"	200	150	201	737	740	737	470	393.5	308	269.88	7.92	64	12-ø39	289	258	Δ
		10"x8"	250	201	252	838	841	838	545	470	362	323.85	7.92	70	16-ø39	319	294	Δ
		12"x10"	300	252	303	965	968	965	610	533.5	419	381	7.92	79.5	20-ø39	407	372	Δ
		14"x10"	350	252	322	1029	1038	1029	640	559	467	419.1	11.13	86	20-ø42	107	372	Δ
		14"x12"	350	303	334	1029	1038	1029	640	559	467	419.1	11.13	86	20-ø42	443	329	Δ
		16"x12"	400	303	373	1130	1140	1130	705	616	524	469.9	11.13	89	20-ø45	443	329	Δ
		16"x14"	400	334	385	1130	1140	1130	705	616	524	469.9	11.13	89	20-ø45	467	345	Δ
		18"x16"	450	373	423	1219	1232	1219	785	686	594	533.4	12.7	102	20-ø51	527	388	Δ
		20"x16"	500	373	471	1321	1334	1321	855	749.5	648	584.2	12.7	108	20-ø54	527	388	Δ
		20"x18"	500	423	471	1321	1334	1321	855	749.5	648	584.2	12.7	108	20-ø54	632	463	Δ
	24"x20"	600	471	570	1549	1568	1549	1040	901.5	772	692.2	15.88	140	20-ø67	715	527	Δ	

Δ Please consult the factory:

Note: The weight value is only for flanged valve. Please consult our factory for higher nominal diameter or weight. Any modification to size Hand, weight will not be notified otherwise.